

M125CH SERIES

1.25mm PITCH WIRE TO BOARD CONNECTOR

● Specifications

Current rating: 1A AC,DC

Voltage rating: 125V AC,DC

Temperature range: -25°C to $+85^{\circ}\text{C}$
(including temperature rise)

Contact resistance: Initial value/10m Ω Max.

After environmental testing/20m Ω Max.

Insulation resistance: 500M Ω MIN

Withstanding voltage: 500V AC/minute

Applicable wire: AWG#28-26

● Standards



E115256

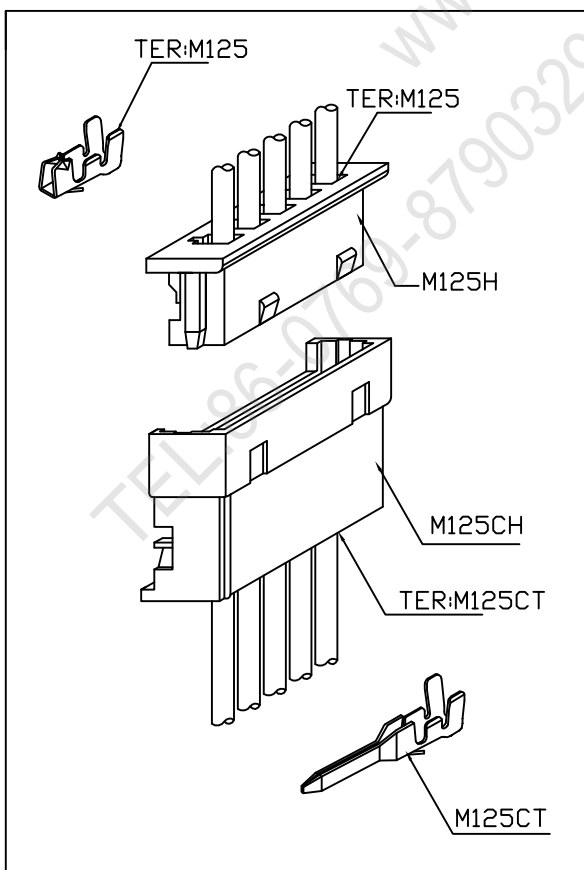

Assembly layout

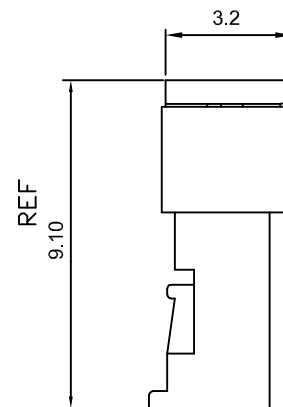

WIRE TO WIRE

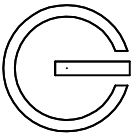

M125CH

1.25mm PITCH HOUSING

Features:

MAT'L: NYLON UL94V-0

MATES WITH: M125CT SERIES TERMINAL

ACCEPTS WITH: M125H SERIES HOUSING

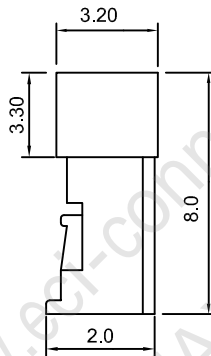
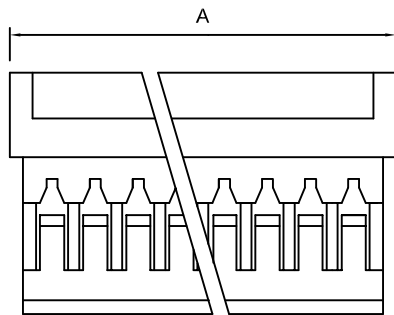
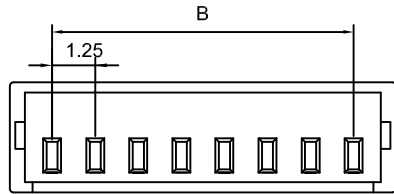

unit: mm

Part NO.	Dim A	Dim B
M125CH-02	7.75	1.25
M125CH-03	9.00	2.50
M125CH-04	10.25	3.75
M125CH-05	11.50	5.00
M125CH-06	12.75	6.25
M125CH-07	14.00	7.50
M125CH-08	15.25	8.75

M125CT

1.25mm PITCH TERMINAL

Features:

THICKNESS: 0.2mm

MAT'L: PHOSPHOR BRONZE TIN PLATED

MATES WITH: M125CH SERIES HOUSING

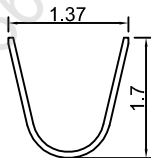

SEC A-A

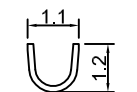

SEC B-B

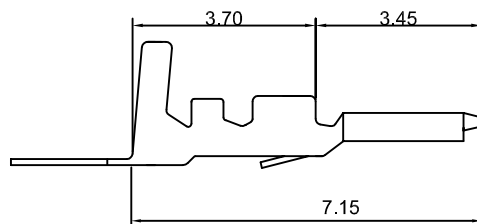
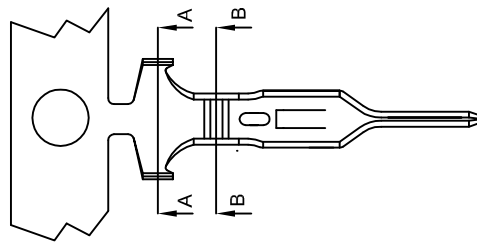

Part No	Wire Range	Insulation O.D.	Material	Finish	Qty/reel
M125CT	AWG#28-26	ø0.9mm MAX	PHOSPHOR BRONZE	Tin-plated	15,000